

## Spa Water Treatment

### Recommended Chemical Values

Chlorine..... 1.5 - 3.0 PPM ( Parts Per Million )  
pH..... 7.4 - 7.6  
Total alkalinity ..... 100 - 120 PPM

It is important to maintain your spa water chemistry to the above values to ensure a healthy experience both for you as bathers and for your spa pool equipment.

### PH

This is a measure of how acid or alkaline the spa water is (below 7.0 is acid, above 7.0 is alkaline). Low pH will cause corrosion of any metalwork in the water (element, thermostat pockets). High pH will cause scale formation and cloudy water.

### Total Alkalinity

This is a measure of how resistant your spa water is to change of pH. A low TA (0 - 80 ppm) will allow the pH to fluctuate rapidly normally to the acid end and will make it very hard to correct the pH back to the ideal range.

### Chlorine

Levels of sanitiser are important to prevent the build up of bacteria, and algae in the pool water. Chlorine is not the only sanitiser available to do this. Other sanitisers are Bromine, Ozone.

Damage to the element, thermostat pockets and associated metalwork due to the poor maintenance of water chemistry is not covered by warranty.



# SPI200



# User's Guide

Models:

SP1200-35 (1ph / 3ph)  
SP1200-45, SP1200-60  
(1ph only)



### Davey Water Products Pty Ltd

Member of the GUD Group  
ABN 18 066 327 517

### Head Office and Manufacturing

6 Lakeview Drive,  
Scoresby, Australia 3179  
Ph: +61 3 9730 9222  
Fax: +61 3 9753 4100  
Website: davey.com.au

### Customer Service Centre

Ph: 1300 2 DAVEY (1300 232 839)  
Fax: 1300 304 850  
E-mail: sales@davey.com.au

### Interstate Offices

Sydney • Brisbane • Adelaide  
Perth • Townsville

### Davey Water Products – New Zealand

7 Rockridge Avenue,  
Penrose, Auckland 1061  
Ph: +64 9 570 9135  
Fax: +64 9 527 7654  
Website: daveynz.co.nz  
E-mail: sales@daveynz.co.nz

### International

6 Lakeview Drive,  
Scoresby, Australia 3179  
Ph: +61 3 9730 9121  
Fax: +61 3 9753 4248  
E-mail: export@davey.com.au

### Davey Spa – New Zealand

2 Rothwell Avenue,  
North Harbour, Auckland 0632  
Ph: +64 9 415 8622  
Fax: +64 9 415 8621  
Website: daveyspa.co.nz  
E-mail: service@daveyspa.co.nz

SP1200 User Guide.pdf  
Booklet Part Number Q916320-1  
23rd November 2009 Version 9



# Contents

1	Basic Operation.....	Pg 1
1.1	- Basic Operation.....	Pg 1
1.2	- SP1200 Touchpad.....	Pg 1
1.3	- LED Indicators.....	Pg 2
1.4	- Pump Selection Page.....	Pg 3
2	User Guide Quick Reference.....	Pg 4
3	Pump Operation.....	Pg 6
3.1	- Pump 1(Two speed, no 24HR circulation pump fitted).....	Pg 6
3.2	- Clean up cycle.....	Pg 6
3.3	- Pump 1 (Two speed, 24HR circulation pump fitted).....	Pg 7
3.4	- Pump 1A & 1B (Single speed pumps, no 24hr circulation pump fitted).....	Pg 8
3.5	- Pump 1A & 1B (Single speed pumps, 24hr circulation pump fitted).....	Pg 8
3.6	- 24Hr circulation pump on/off.....	Pg 9
4	Auxiliary on/off.....	Pg 9
5	Spa Power Variable Speed Blower (SPVSB).....	Pg 9
5.1	- Adjustable speed mode(SPVSB).....	Pg 9
6	Spa Power Variable Colour Light (SPVCL).....	Pg 10
6.1	- Adjustable light intensity mode.....	Pg 10
6.2	- Light effect mode.....	Pg 11
6.2.1	- Adjusting the light effect mode speed.....	Pg 11
7	Menu Structure.....	Pg 12
7.1	Main Menu.....	Pg 13
7.2	- Set temp.....	Pg 14
7.3	- User timer.....	Pg 15
7.4	- Clock.....	Pg 15
7.4.1	- Setting the clock.....	Pg 16
7.5	- User Alarm.....	Pg 17
7.5.1	- Configuring a user alarm.....	Pg 17
7.5.2	- Disabling a user alarm.....	Pg 18
7.6	- Sleep timer.....	Pg 19
7.6.1	- Configuring a sleep time.....	Pg 19
7.6.2	- Disabling a sleep time period.....	Pg 21
7.6.3	- Plumbing Purge.....	Pg 21
7.7	- Maintenance Timers.....	Pg 21
7.7.1	- Maintenance timer configuration.....	Pg 22
7.7.2	- Acknowledging a maintenance timer.....	Pg 22
7.7.3	- Configuring a maintenance timer.....	Pg 23
7.7.4	- Disabling a maintenance timer.....	Pg 23
7.8	- Miscellaneous Options Submenu.....	Pg 24
7.8.1	- Key clicks on/off.....	Pg 24
7.8.2	- Main display.....	Pg 25
7.8.3	- Changing main display.....	Pg 25
7.8.4	- Panel colour and intensity.....	Pg 25
7.8.5	- Changing the touch pad back light colour.....	Pg 25
7.8.6	- Changing the touch pad back light intensity.....	Pg 25
7.8.7	- Panel and pool light synchronisation (on/off).....	Pg 26
7.8.8	- Enabling/disabling light synchronisation.....	Pg 26
7.9	- Advanced Options Submenu.....	Pg 26
7.9.1	- Heat Control.....	Pg 27
7.9.2	- Changing heat control setting.....	Pg 27
7.9.3	- High heat offset.....	Pg 27
7.9.4	- Changing high heat offset setting.....	Pg 28
7.9.5	- Auto filtration/Sanitising (n/a for 24hr circ models).....	Pg 28
7.9.6	- Adjusting the filtration time.....	Pg 28
7.9.7	- Adjusting the filtration period.....	Pg 28
7.10	- Load factory Defaults.....	Pg 29
7.10.1	- Restoring factory defaults.....	Pg 29
8	Additional Features.....	Pg 30
8.1	- Touch pad key lock.....	Pg 30
8.2	- Activating the key lock.....	Pg 30
8.3	- Disabling key lock.....	Pg 30
8.4	- Adjusting Touch pad LCD Contrast.....	Pg 30
8.5	- Display Reversing.....	Pg 31
8.6	- Language Selection.....	Pg 31
9	Self Diagnostic Error Codes.....	Pg 32

## Error 5 (“OVER TEMP”) Over Temperature

This error indicates that one of the digital temperature sensors in either the heater or pool has detected a temperature of 45°C or more. This may not be a problem with the SP1200. It may be caused by excessive pump use in hot weather or pump failure. Turn off the spa and allow time for the water to cool then manually push the Light Level, Light Effect Mode, Pump 1A and Pump 2A buttons simultaneously. If there is still a problem then contact your spa pool supplier.

## Error 6 (“THERMAL CUT OUT”) - Thermal Cut Out Tripped

This error indicates that the safety electromechanical over temperature cut out on the heater has operated. This is not necessarily a problem with the SP1200. It may have occurred from an air lock around the element, high temperatures during shipping, or pump failure. This automatic cut out will only reset once the element has cooled below about 38°C. The unit must then be reset before it will resume operation by manually pushing the Light Level, Light Effect Mode, Pump 1A and Pump 2A buttons simultaneously. If there is still a problem then contact your spa pool supplier.

## Error 7 (“STUCK RELAY”) - Stuck Relay

This error indicates a problem with the heater control circuitry inside the unit. Contact your spa pool supplier.

## Error 8 (“NO TEMP DATA”) - No Temperature Data

This error indicates a problem with the digital temperature sensor in the heater or pool wall. The sensor may have become disconnected or damaged. Try to reset the spa. If there is still a problem then contact your spa pool supplier.

## Error 9 (“CLOCK FAULT”) Real Time Clock Failure

This error indicates a problem with the real time clock within the SP1200. Try to reset the spa. If there is still a problem then contact your spa pool supplier.

# Warnings

## Warning 1 (“TEMP SENSOR FAILURE”) - Temperature sensor failure

This warning indicates that one of the two digital temperature sensors in either the heater or pool is no longer functioning correctly. The spa is able to continue operating using the other sensor, however there is probably a fault. Contact your spa pool supplier.

If this warning appears when first commissioned it maybe that the controller needs to be set back to factory default. To set load factory defaults see page 29.

## Safety Notes

Before using ensure that the spa pool has been connected to a suitable weather protected outlet socket, equipped with a double pole isolating switch, which is of the correct rating and complies with the local wiring regulations.

When installing, refer to your local wiring code. In particular refer to ECP2 & ECP25 (AS/NZ) and EN60364-4-1 & EN60364-7-1 (EU). The system must be installed in such a way that live parts are not accessible by a person in the pool. If a supply cord is not fitted the system must be permanently connected to fixed wiring through a 30mA or less RCD.

It is recommended that the steel reinforcing in any concrete base on which the pool is sitting be equipotential bonded to the earth conductor in the supply to the spa. This is to protect against the possibility of low voltage shocks caused by differential earth voltages. Refer to AS/NZS3000:2000 Sections 5.8 & 7.2 or EN 60364.

This appliance is not intended for use by young children or infirm persons without supervision. Young children should be supervised to ensure they do not play with the appliance.

## 9 Self-Diagnostic Error Codes

The Spa Power 1200 controller has extensive self diagnostic capabilities. In the event of a problem it will indicate a warning or error according to the nature of the problem. The spa will continue operating if a warning is produced but user intervention or service is required for errors.

### Errors

When in an error state the alarm can be silenced by pressing the SCROLL button. The alarm will automatically silence after four minutes.

#### Error 1 ("PRIME FAILED") Water Prime Failed

Prime failed is a special case. This is not necessarily a problem with the SP1200 itself, but indicates that no water is being detected in the heater housing. On a push of the DOWN button the main pump will run for 10 seconds to try to get water to the heater. If successful normal operation will resume. If unsuccessful, the error will be indicated on the display again. Note: When this error occurs you will also be given the option to run the SP1200 in demo mode, this feature is not intended for end users. If you inadvertently enter demo mode, reset the spa to start over.

With any Error 3-8, spa operation will stop and not continue until the controller is reset. The controller can only be reset by pushing the Light Level, Light Effect Mode, Pump 1A and Pump 2A buttons simultaneously. The controller will remain in an error condition even when reset at mains power, controller will only continue normal operation after the Light Level, Light Effect Mode, Pump 1A and Pump 2A buttons are pushed simultaneously (see below).



#### Error 3 ("STUCK BUTTON") - Stuck Button

This error indicates that one or more of the touch pad buttons is stuck or has been held down for more than one minute. This may be caused by the pool cover pressing on the touch pad or by water getting into the touch pad or by damage to the touch pad itself. Try to reset the spa. If there is still a problem then contact your spa pool supplier.

#### Error 4 ("NO WATER SENSOR") - No Water Sensor

This error indicates a problem with the optical water sensor in the heater. The problem may be caused by the sensor being disconnected or by damage to the sensor. Try to reset the spa. If there is still a problem then contact your spa pool supplier.

## 1 Introduction

**Congratulations** on choosing Spa-Quip's top of the line Spa Power control system.

This controller offers a large range of possible accessories, a user friendly touchpad and superior components. It makes use of the latest electronics, display and sensor technology to provide you with the most sophisticated controller in its class.

### 1.1 Basic Operation

The SP1200 touch pad features a large display consisting of four numerical digits and two lines of text. The display typically shows three quantities - Current pool temperature, Set (Target) pool temperature and clock (weekday and time). By default the current pool temperature is displayed on the numerical digits leaving the clock and set temperature on the two lines of text. This configuration may be changed by the user if a different layout is preferred.

Whenever a touch pad button is pressed the two lines of text will temporarily describe the newly selected state. Likewise when the controller is busy performing a task, text will be displayed to explain what is happening (examples include sleeping, purging pumps and water priming). Each of these messages and the associated function is described in the following sections.

### 1.2 SP1200 Touchpad

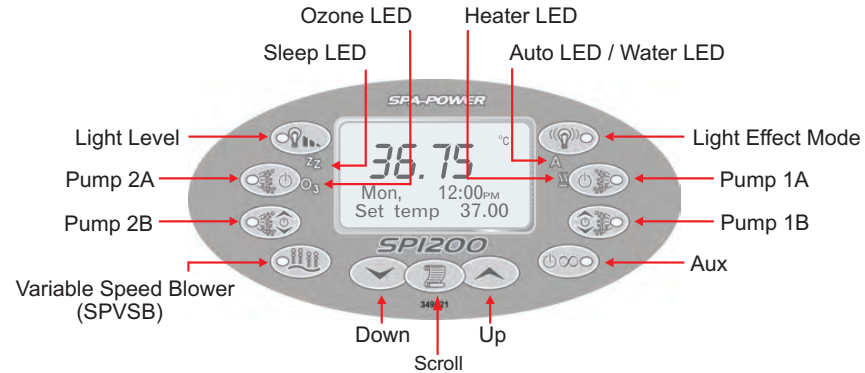

### 1.3 LED Indicators

**Auto (Non-24HR circ model)** This LED is green when automatic control is enabled and off when pump 1 is under manual control. In automatic mode pump 1 runs as required to heat the pool and ensure minimum filtration times are met. If the indicator is blinking it means that the water sensor is not detecting any water in the heater housing. If no water is being detected the LCD Display will also show "WATER PRIMING, PLEASE WAIT".

**Water (24HR circ model)** This LED is green when water is detected. If the indicator is blinking it means that the water sensor is not detecting any water in the heater housing. If no water is being detected the LCD Display will also show "WATER PRIMING, PLEASE WAIT".



**Heater** This LED shows when the heater is on. The heater will turn on and off as required whenever the pump is running. The LED is red when the heater is on high and orange when on low. The low setting is used for load shedding to keep the total controller load within safe limits while still providing some heating effort.



**Sleep** This LED is on whenever the controller is within a designated sleep period. When the controller is asleep the LED is green but the LED colour will change to orange if manually awoken. During the sleep state the LCD Display will also show "SLEEPING, PRESS ANY KEY".

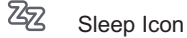

**Ozone** This LED is green whenever the ozonator (if fitted) is on. Pressing any touch pad button may automatically turn off the ozonator (depending on installer configuration). If this occurs, the ozonator will not switch back on until approximately 30 minutes after the last touch pad button press.



### 8.5 Display Reversing

The display can be reversed so it can be read from inside or outside of the spa pool, the display will revert back to default state after 30 minutes of inactivity.

To reverse the display press the UP and DOWN buttons simultaneously  
To restore the display press the UP and DOWN buttons again.

Default Display Orientation



Reversed Display Orientation



### 8.6 Language Selection

The SP1200 spa controller can be set to display English (default), French, German, Spanish, Dutch & Japanese.

To select language press and hold the DOWN button for 4 seconds.



Use the UP or DOWN buttons to select language then press the SCROLL button to set.



Scroll to SET

## 8 Additional Features

### 8.1 Touch Pad Key Lock

The SP1200 touch pad buttons can be locked to prevent unauthorised people from using the spa or modifying set up options. While the key lock is active button presses are ignored, however the LCD Display will temporarily show "KEYS LOCKED" to alert the user that the key lock is engaged.

### 8.2 Activating The Key Lock

To activate the key lock press and hold down the DOWN, SET and UP buttons together. While you are doing this, the LCD Display will show "HOLD KEYS TO ACTIVATE LOCK". You will need to hold the buttons down for approximately three seconds before the lock is activated. At this point the touch pad will beep and show "KEYS LOCKED".



### 8.3 Disabling The Key Lock

Once the key lock has been activated a button press sequence is required to disable it. Press each of the buttons listed in the unlock sequence, one at a time. The touch pad will beep and temporarily display "KEYS UNLOCKED" once the sequence is correctly entered. If you loose your place or incorrectly enter one of the buttons start over from the first step.

Unlock sequence: DOWN, SCROLL, DOWN, UP, SCROLL.

Note: If the controller is switched off while the key lock is active, the key lock will not be restored when power is reapplied.

### 8.4 Adjusting Touch Pad LCD Contrast

The touch pad LCD contrast/brightness can be manually adjusted if the display appears too dark or light.

To adjust the contrast, follow these steps:

- 1) Press and hold down the LIGHT button. This will cycle the light intensity as usual, however you must keep the button held down before proceeding with the following steps.
- 2) With the LIGHT button held down, press the UP or DOWN buttons to darken or lighten the contrast as required. Hold down either button for automatic key press repeat. As you press the UP and DOWN buttons no key clicks or display changes will occur - this is normal.
- 3) Once you have finished adjusting the contrast release the LIGHT button and the new setting will be saved.

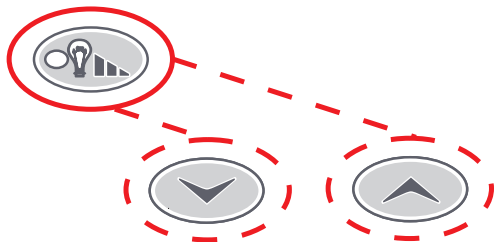

## 1.4 Pump Selection Page

Before reading the following user guide please take note of your pump type then refer to the page stated to learn how to operate your spa pool controller. Use the table below to determine which pump type you have on your spa.



Push  (Pump 1A) 4 times and match the display on your touch pad to the column in the table below, then refer to the specified section.

Option 1	Option 2	Option 3	Option 4
SEE SECTIONS 2.1.1 (page 4) 3.1 (page 6)	SEE SECTIONS 2.1.2 (page 4) 3.3 (page 7)	SEE SECTIONS 2.1.3 (page 4) 3.4 (page 8)	SEE SECTIONS 2.1.4 (page 4) 3.5 (page 8)

## Section 2.0

# SPI200 User's Guide Quick Reference

## 2.1 Pump 1 Operation

### 2.1.1 Two Speed (no 24hr circulation pump)

 Pump 1A button: Push to change pump mode (PUMP AUTO, MANUAL ON ,MANUAL OFF)

 Pump 1B button: Push to change pump speed (LOW, HIGH)

### 2.1.2 Two Speed (24hr circulation pump fitted)

 Pump 1A button: Push to turn pump ON/OFF

 Pump 1B button: Push to change pump speed (LOW, HIGH)

### 2.1.3 Single Speed (no 24hr circulation pump)

 Pump 1A button: Push to change pump mode (PUMP AUTO, MANUAL ON ,MANUAL OFF)

 Pump 1B button: Push to turn ON/OFF additional pump (if fitted)

### 2.1.4 Single Speed (24hr circulation pump fitted)

 Pump 1A button: Push button to turn pump ON/OFF

 Pump 1B button: Push to turn ON/OFF additional pump (if fitted)

For more detailed information please see section 3.

## 2.2 Pump 2 Operation

### 2.2.1 Single Speed Pump

 Pump 2A button: Push to turn ON/OFF additional pump (if fitted)

 Pump 2B button: Push to turn ON/OFF additional pump (if fitted)

### 2.2.2 Two Speed Pump

 Pump 2A button: Push to turn pump ON/OFF

 Pump 1B button: Push to change pump speed (LOW, HIGH)

For more detailed information please see section 3.

## 2.3 Aux (Pump, Blower, Light)

 Push button to turn Aux output ON/OFF

For more detailed information please see section 4.

## 7.10 Load Factory Default Settings

The load defaults option provides a way of restoring all factory default settings. These include obvious set up parameters such as set temperature and sleep times but also settings such as preferred light mode, light effect speeds and blower speed will be restored to their factory defaults. Only use this option if you are absolutely sure it is necessary.

### 7.10.1 Restoring Factory Defaults

- 1) Select the LD. DEFAULTS item from the main menu.(see below for details)
- 2) Press the SCROLL button. Note that the confirmation prompt uses a very short timeout (approximately three seconds) and as such you will have to execute the following steps relatively quickly.
- 3) Press the UP or DOWN button to select "YES".
- 4) Press the SCROLL button to load the defaults. The display will temporarily show "DEFAULTS LOADED" to confirm that defaults have been loaded.

Select MAIN menu then push UP button nine times

Push 9

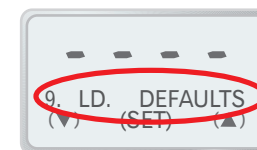

1. SET TEMP
2. USER TIMER
3. CLOCK
4. USER ALARM
5. SLEEP TIMES
6. MAINT TIMERS
7. MISC OPTIONS
8. ADV. OPTIONS
9. LD. DEFAULTS

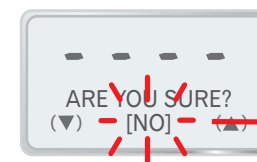

[NO]  
[YES]



Scroll to SET

#### Notes

- 1) After the defaults have been loaded, it takes approximately 10 seconds for the controller to save them. Do not turn off the power before this period elapses.
- 2) The clock hour, minute and weekday will not be reset when you load the defaults

### 7.9.4 Changing The High Heat Offset Setting

- 1) Select the ADV. OPTIONS submenu from the main menu.
- 2) Select the HIGH HT OFFS menu item.
- 3) Press the Scroll button to begin high heat offset modification.
- 4) Use the UP and DOWN buttons to adjust the offset as required. Hold down either button for automatic key press repeat.
- 5) Press the SCROLL button to confirm the current setting and return to the ADV. OPTIONS submenu.

### 7.9.5 Auto Filtration/Sanitising (N/A for 24HR Circ Installations)

Automatic filtration is provided to ensure that the pool water is filtered for at least a minimum time each day regardless of how often the pool is used for normal operation or how long the pump runs for heat maintenance. If the pump has not run long enough during normal operation the system will automatically run it for an additional period to meet the minimum filtration time as specified by the user. This feature is especially useful in warmer climates where very little automatic heating (and hence water filtration) is necessary to keep the pool water at the set temperature.

Automatic filtration consists of two user adjustable settings - Filtration Time and Filtration Period. These settings are located in the advanced options submenu.

### 7.9.6 Adjusting The Filtration Time

The Filtration Time setting specifies the minimum filtration time and can be adjusted between 0 and 30 minutes per hour (effectively 0 to 12 hours per day), default 10 minutes. A setting of 0 minutes totally disables automatic filtration.

- 1) Select the ADV. OPTIONS submenu from the main menu.
- 2) Select the FILT. TIME menu item.
- 3) Press the SCROLL button to begin Filtration Time modification.
- 4) Use the UP and DOWN buttons to set the desired filtration time in minutes per hour.
- 5) Press the SCROLL button to confirm the current setting and return to the ADV. OPTIONS submenu.

### 7.9.7 Adjusting The Filtration Period

The Filtration Period setting specifies how often the system should run the pump to ensure the minimum filtration time is met. Available settings are 1, 2, 3 or 4 hours. At the default setting of 1 hour, the pump will come on no more than once an hour to ensure filtration times are met, similarly a setting of 4 hours indicates that a filtration run will occur once every 4 hours.

- 1) Select the ADV. OPTIONS submenu from the main menu.
- 2) Select the FILT. TIME menu item.
- 3) Press the SCROLL button to begin Filtration Period modification.
- 4) Use the UP and DOWN buttons to set the desired filtration period.
- 5) Press the SCROLL button to confirm the current setting and return to the ADV. OPTIONS submenu.

Please note that although the filtration period restricts how often filtration-only runs occur, normal heating maintenance may take place in between the filtration runs. If this occurs it may appear as though the filtration period setting is not functioning correctly, however this behaviour is normal. Excessive cycling of the spa will not be cured by increasing the filtration period, please read "Heat Control" for more information.

**Notes**

- 1) On every day of the year we experience different ambient temperatures. As a result the spa pump will run for different periods at different times every day, depending on how often the pump runs to heat the water.
- 2) Any modification of filtration settings (either time or period) will cause the current filtration timing to be reset and automatic filtration maintenance will not continue until the first hour of the next filtration period.
- 3) Filtration cycles will always trigger heating if the pool is below the temperature set point regardless of the heat mode setting.
- 4) Filtration does not operate during sleep periods.

### 2.4 Variable Speed Blower Operation



Push button to turn blower ON/OFF and select operating mode (HIGH,RAMPING,VARIABLE SPEED)



Use the up and down buttons to adjust the blower speed

**For more detailed information please see section 5.**

### 2.5 Variable Colour Light Operation



Light level button: Push to turn light ON/OFF and alter brightness.



Light mode button: Push to change the light effects.

**For more detailed information please see section 6.**

### 2.6 Setting The Temperature



Push 1 = Main Menu display appears (see below)



Push 1 = Set Temp display appears (see below)

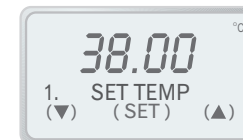

Push the SCROLL button to alter temperature



**Or**



Use the up and down buttons to select desired temperature



Push the Scroll button to save the current setting.

**For more detailed information please see section 6.2**

## 3 Pump Operation

### 3.1 Pump 1 (Two speed, no 24HR circulation pump fitted)

Pump 1 is controlled via two touch pad buttons - one to turn the pump on/off and another to change its speed. When the spa is running in PUMP AUTO mode, pressing either button will deactivate that mode and set the pump running in low speed. The pump speed selected by these buttons are shown for a few seconds on the LCD display as well as being indicated by several LEDs. The auto LED is green when PUMP AUTO mode is enabled and off when in PUMP OFF mode, likewise the two pump button LEDs are green, red or off when the pump is on-low, on-high or off respectively.

#### Push 1 (Pump On)



LCD displays "PUMP LOW", auto LED off, button LEDs green. This mode is used to switch on pump 1 even when the system is asleep or doesn't need to run the pump in automatic mode for heating or filtration.

#### Push 1 (Pump Hi)



The Hi/Low speed button can be used to change the pump speed:

#### Push 2 (Pump Low)



#### Push 2 (Pump Off)



LCD displays "PUMP OFF", auto LED off, button LEDs off. This mode is used to turn pump 1 off for quiet relaxation. The Hi/Low speed button has no effect in this mode.

#### Push 3 (Pump Auto)



LCD displays "PUMP AUTO", auto LED green. This is the default start up mode in which pump 1, heating and filtration are automatically controlled. Pressing the Hi/Low speed button has the same effect as pressing the On/Off button in this mode.

### 3.2 Clean up cycle

If desired, a clean up cycle can be initiated to filter the water after the pool has been used. To do this, simply press the pump on/off button to leave auto mode and switch on the pump. This will run the pump for a fixed period of time (90 minutes) circulating the water through the filter. The system will then return to auto mode and maintain the temperature ready for the next time the pool is used.



Press the pump button to enter PUMP LOW and filter the water for 90 minutes

#### Notes:

- 1) The heater will turn on and off as required any time pump 1 is running in either PUMP AUTO or PUMP ON States.
- 2) PUMP AUTO will be activated after 90 minutes of touch pad inactivity, if left in PUMP ON or PUMP OFF states.

## 7.9.1 Heat Control

In addition to set temp the user may also select one of four heat control settings. The set temp determines the maximum temperature before the spa will stop heating the water, whereas the heat control setting determines how far the temperature must drop before heating resumes again. In other words, the heat control setting determines how closely the spa will maintain the pool temperature to the set temperature.

The four available settings are as follows:

1. TIGHT	0.25	2.50
2. NORMAL (default setting)	0.50	3.00
3. LOOSE	0.75	3.50
4. EXTRA LOOSE	1.00	4.00

The numbers associated with each setting in the table reflect the actual decrease in pool temperature below the set point before heating will begin (hysteresis). Two sets of values are listed: 0.25 - 1.00 and 2.50 - 4.00. Generally the first set is used, however if you do not have an in-pool temperature sensor or 24 hour circulation pump fitted the second set will be used instead.

There is a direct compromise between how often the spa cycles on/off and how closely the temperature is maintained to the set temperature. Using the "tight" setting will maintain the temperature very closely to the set temperature but in doing so it will also cause the spa to cycle on/off frequently. Conversely, using the "extra loose" setting will cause a larger variation in pool temperature but the spa will cycle much less frequently.

Exactly how often the spa will cycle on/off at each setting is a complex function of ambient conditions and the thermal characteristics of your spa - set temp, spa body insulation, cover insulation, heater rating etc. It is recommended that you start with the default "normal" setting and only change to another setting if you would prefer a different compromise of cycling frequency and temperature variation.

### 7.9.2 Changing The Heat Control Setting

- 1) Select the ADV. OPTIONS submenu from the main menu.
- 2) Select the HEAT CONTROL menu item.
- 3) Press the SCROLL button to begin heat control setting selection.
- 4) Use the UP and DOWN buttons to select heat control setting (refer table).
- 5) Press the SCROLL button to confirm the current setting and return to the ADV. OPTIONS submenu.

#### Notes

- 1) When the pool is in use the hysteresis is automatically limited to a maximum of 0.50 degrees Celsius to ensure the water doesn't get too cold.
- 2) The start of a filtration cycle will always trigger heating if the temperature is below the set point regardless of the heat control setting.

### 7.9.3 High Heat Offset

The SP1200 is equipped with a dual stage heater - low and high. The high setting uses the full rated power of the element whereas the low setting uses approximately half of the rated power. The colour of the heater LED changes depending on which setting is used, it is red when the heater is on high and orange when on low.

The high heat offset setting allows you to configure how far below the set point the water temperature must fall before the high setting is used. By default this feature is disabled and the controller will attempt to use the high setting whenever heating is required. Note that high heat may not always be available due to possible load shedding when accessories are turned on (depends on installer configuration).

Range of adjustment is 0.00 (default, off) to 5.00 in steps of 0.25 degrees Celsius. At the maximum setting of 5.00, the pool water must be five or more degrees below the set temperature before the high setting will be used.



## 7.8.7 Panel And Pool Light Synchronisation (on/off)

The SP1200 touch pad backlight has the ability to mirror the colour and intensity of the in-pool Spa Power Variable Colour Light (SPVCL). This feature is most noticeable when a light effect mode is being used and the light colour is changing rapidly.

When the pool light is turned off the touch pad backlight will remain one user selectable fixed colour. If desired the synchronising/mirroring feature can be disabled and the touch pad backlight will remain on the fixed colour even when the pool light is turned on.

## 7.8.8 Enabling/Disabling Light Synchronisation

- 1) Select the MISC OPTIONS submenu from the main menu.
- 2) Select the PANEL & POOL LT. SYNC menu item
- 3) Press the SCROLL button modify light synchronisation setting
- 4) Use the UP and DOWN buttons to toggle between on and off
- 5) Press the SCROLL button to set.





Note: This option is only available if a SPVCL (Spa Power Variable Colour Light) is in the pool.

## 7.9 Advanced Options Submenu

The advanced options menu contains settings that should only be modified after you are familiar with the basic operation of the spa. The defaults will generally be satisfactory and will probably not need to be changed.

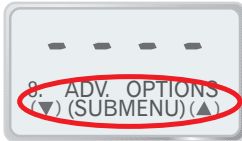
Select MAIN menu then push UP button 8 times

**Push 8** 

Scroll to SET

1. SET TEMP
2. USER TIMER
3. CLOCK
4. USER ALARM
5. SLEEP TIMES
6. MAINT TIMERS
7. MISC OPTIONS
8. ADV. OPTIONS
9. LD. DEFAULTS

1. HEAT CONTROL
2. HIGH HT OFFS
3. FILT. PERIOD\*
4. FILT. TIME\*

\*N/A circulation pump installations

## 3.3 Pump 1 (Two speed, 24HR circulation pump fitted)

This pump is controlled via two touch pad buttons - one to turn the pump on/off and another to change its speed. The mode and pump speed selected by these buttons are shown for a few seconds on the LCD display as well as being indicated by the pump button LEDs. The two pump button LEDs are green, red or off when the pump is on-low, on-high or off.

### Pump 1

Two pushes of the on/off button cycles the pump as follows:

**Push 1 (Pump On)**



**Push 1 (Pump Hi)**



The Hi/Low speed button can be used to change the pump speed:

**Push 2 (Pump Low)**



**Push 2 (Pump Off)**



LCD displays "PUMP OFF", button LEDs off. The Hi/Low speed button has no effect in this mode.

### Pump 2

Two pushes of the on/off button cycles the pump as follows:

**Push 1 (Pump On)**



**Push 1 (Pump Hi)**



The Hi/Low speed button can be used to change the pump speed:

**Push 2 (Pump Low)**



**Push 2 (Pump Off)**





LCD displays "PUMP OFF", button LEDs off. The Hi/Low speed button has no effect in this mode.

Notes:

- 1) If left on, these pumps will automatically switch off after 25 minutes.
- 2) If the heater element is on, running either pump in high speed mode may cause the heater to load shed and switch off. If this occurs the heater will come back on approximately 5 seconds after high speed is deselected (pump running in low speed or pump off).

### 3.4 Pump 1A & 1B (Single speed pumps, no 24hr circulation pump fitted)



Three pushes of the Pump 1A button cycles the pump as follows:

<b>Push 1 (Pump On)</b>		LCD displays "PUMP ON", button LEDs green.
<b>Push 2 (Pump Off)</b>		LCD displays "PUMP OFF", button LEDs off.
<b>Push 3 (Pump Auto)</b>		LCD displays "PUMP AUTO", button LEDs green.

Notes:

- 1) If Pump 1A is left in "PUMP ON" or "PUMP OFF" modes, this pump will automatically revert to "Auto" mode after 90 minutes.
- 2) If the heater element is on, running the pump may cause the heater to load shed and switch off. If this occurs the

Two pushes of the Pump 1B button cycles the pump as follows:



<b>Push 1 (Pump On)</b>		LCD displays "PUMP ON", button LED green.
<b>Push 2 (Pump Off)</b>		LCD displays "PUMP OFF", button LED off.

Notes:



- 1) If Pump 1B is left on, this pump will automatically switch off after 25 minutes.
- 2) If the heater element is on, running the pump may cause the heater to load shed and switch off. If this occurs the heater will come back on approximately 5 seconds after the pump is deselected.

### 3.5 Pump 1A & 1B (Single speed pumps, 24hr circulation pump fitted)

Two pushes of the Pump 1A button cycles the pump as follows:

<b>Push 1 (Pump On)</b>		LCD displays "PUMP ON", button LED green.
<b>Push 2 (Pump Off)</b>		LCD displays "PUMP OFF", button LED off.

Two pushes of the Pump 1B button cycles the pump as follows:

<b>Push 1 (Pump On)</b>		LCD displays "PUMP ON", button LED green.
<b>Push 2 (Pump Off)</b>		LCD displays "PUMP OFF", button LED off.

Notes:

- 1) If Pump 1A or Pump 1B is left on, these pumps will automatically switch off after 25 minutes.
- 2) If the heater element is on, running the pump may cause the heater to load shed and switch off. If this occurs the heater will come back on approximately 5 seconds after pump is deselected.

## 7.8.2 Main Display

The SP1200 touch pad LCD consists of two lines of text and four numerical digits. The display typically shows three quantities - pool temperature, set temperature and the clock (weekday and time). By default the pool temperature is displayed on the numerical digits leaving the clock and set temperature on the two lines of text.

If preferred, the user may change the layout so either the set temperature or clock are shown on the main display (four numerical digits) rather than on the smaller text lines. In addition a cycling mode can be selected whereby each of the three possible views is presented for 10 seconds each.

Available options:

1. POOL TEMP (default setting, set temp and clock on text lines)
2. SET TEMP (clock and pool temp on text lines)
3. CLOCK (set temp and pool temp on text lines)
4. CYCLING (cycles through the above views 1 – 3 for 10 seconds each)

## 7.8.3 Changing The Main Display

- 1) Select the MISC OPTIONS submenu from the main menu.
- 2) Select the MAIN DISPLAY menu item
- 3) Press the SCROLL button to begin main display selection.
- 4) Use the UP and DOWN buttons to set the desired view.
- 5) Press the SCROLL button to confirm the current setting and return to the MISC OPTIONS submenu.

## 7.8.4 Panel Light Colour And Intensity

The user has the ability to change the touch pad backlight colour and intensity to their preferred settings. Note that these manual settings will only take effect when either the pool light is off or if the "panel and pool light synchronisation" option has been disabled

## 7.8.5 Changing The Touch Pad Backlight Colour

- 1) Select the MISC OPTIONS submenu from the main menu.
- 2) Select the PANEL LIGHT COLOUR menu item
- 3) Press the SCROLL button to begin light colour selection.
- 4) Use the UP and DOWN buttons to set the desired colour.
- 5) Press the SCROLL button to confirm the current setting and return to the MISC OPTIONS submenu.

## 7.8.6 Changing The Touch Pad Backlight Intensity

- 1) Select the MISC OPTIONS submenu from the main menu.
- 2) Select the PANEL LIGHT INTENSITY menu item.
- 3) Press the SCROLL button to begin light intensity adjustment.
- 4) Use the UP and DOWN buttons to set the light intensity.
- 5) Press the SCROLL button to confirm the current setting and return to the MISC OPTIONS submenu.

Please note that the backlight intensity setting only has effect when the pool is in use. After 90 minutes of touch pad inactivity (no button presses) the backlight intensity will automatically return to a fixed 34% setting. This is to ensure long life of the backlight LEDs. As soon as you press a button on the touch pad your custom setting will be restored.







- Pressing the Air button while the blower is running will only cycle through the available options when the LCD is displaying the current selection. This allows you to set the function of the UP and DOWN buttons and to view the current Blower setting without changing it.
- Pressing either the UP or DOWN button while in the full-speed or oscillating mode will automatically change the SPVSB to adjustable speed mode.
- If left on, this accessory will automatically switch off after 25 minutes.
- If the heater element is on, switching on the SPVSB may cause the heater to load shed and switch off. If this occurs the heater will come back on approximately 5 seconds after the SPVSB is turned off.

## 6 Spa Power Variable Colour Light (SPVCL)

The Spa Power Variable Colour Light is controlled via two touch pad buttons - Light Level and Light Effect Mode. If no SPVCL is fitted then the buttons can still be used to produce lighting effects on the touch pad as though a light was fitted.

The Light Level button selects the intensity of the light and the Light Effect Mode button selects the light colour and effect.

Five pushes of the Light level button selects the light intensity as follows:

- Push 1 (High)**  LCD Displays "LIGHT HIGH", 100% light intensity
- Push 2 (Medium)**  LCD Displays "LIGHT MEDIUM", 66% light intensity
- Push 3 (Low)**  LCD Displays "LIGHT LOW", 33% light intensity
- Push 4 (Adjust)**  LCD Displays "LIGHT ADJUST", adjustable light intensity mode, button LED colour changes with setting when up or down buttons are pressed. (Green 2-32, Orange 34-66, Red 68-100%) (See "Adjustable Light Intensity Mode" in next section for more details.)
- Push 5 (Off)**  LCD Displays "LIGHT OFF", light off

Pressing the UP or DOWN button while in high, medium or low mode will automatically change to adjustable mode.

### 6.1 Adjustable Light Intensity Mode

In the adjustable light intensity mode the UP and DOWN buttons are used to set the light between 2 and 100 percent of maximum intensity. On the first press of UP/DOWN the LCD will display "LIGHT ADJUST" along with a bar graph showing the current setting. While viewing this display you may press the UP and DOWN buttons to adjust the intensity as required. Hold down either button for automatic key press repeat. This setting is saved and will be automatically restored next time you select the adjustable light intensity mode.

**Push 4 (Light Adjust)** 

**Down**  **Up** 

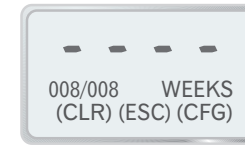
- Press the DOWN button to reset the week count to zero.

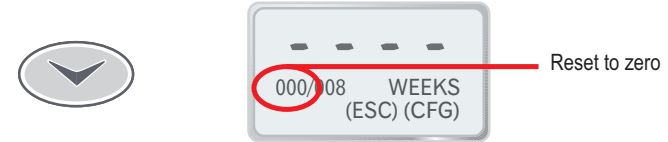

- Press the SCROLL button to confirm and move to the next field.



## 7.7.3 Configuring A Maintenance Timer

Follow these steps to modify the total number of weeks or the number of elapsed weeks for a given maintenance timer:

- Select the MAINT TIMERS submenu.
- Select the desired maintenance timer using the UP and DOWN buttons.
- Press the SCROLL button once to view the maintenance timer options.
- Press the UP button once to begin timer configuration. The Total Weeks field begins to flash.
- Use the UP and DOWN buttons to adjust the selected field as required. Hold down either button for automatic key press repeat.
- Press the SCROLL button to confirm the current setting and move to the next field.
- Repeat steps 5 and 6 to set the number of weeks already elapsed. Generally you will want to leave this field at 0 - the start of the timed period.
- Press the SCROLL button once to return to the maintenance timer submenu.

## 7.7.4 Disabling A Maintenance Timer

If you want to disable a maintenance timer follow the procedure outlined above until you reach step 5. At this point press the DOWN button until the Total Weeks field is 0. Press the SCROLL button once to save the new setting and return to the maintenance timer options view. This will completely disable the maintenance timer.

Notes:

- Lowest numbered timers have the highest priority and will be shown first if two or more timers are due at the same time. Clearing the first maintenance timer will result in the controller notifying you that next highest priority timer is due.
- The maintenance timers will not accumulate time while the controller is turned off.

## 7.7.1 Maintenance Timer Configuration

The installer, serviceman or owner can fill in the table below to help keep track of what settings have been entered into the controller.

Timer name	Period (weeks)	Description/notes
1. General service		
2. Cabinet service		
3. Replace filter		
4. Ozonator		
5. Custom #1		
6. Custom #2		
7. Custom #3		
8. Custom #4		
9. Custom #5		

## 7.7.2 Acknowledging a maintenance timer

Once a timer is due you need to manually clear it - it will not clear by itself. Follow these steps to clear a maintenance timer that is currently due:

- 1) Select MAIN menu then push UP button six times

Push 6



1. SET TEMP
2. USER TIMER
3. CLOCK
4. USER ALARM
5. SLEEP TIMES
6. MAINT TIMERS
7. MISC OPTIONS
8. ADV. OPTIONS
9. LD. DEFAULTS

- 2) Press the SCROLL button then the UP button as required to select the maintenance timer to be cleared.

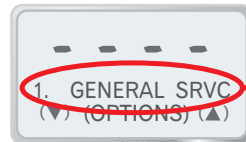

1. GENERAL SRVC
2. CABINET SRVC
3. REPLACE FLTR
4. OZONATOR
5. CUSTOM #1
6. CUSTOM #2
7. CUSTOM #3
8. CUSTOM #4
9. CUSTOM #5



Scroll to SET

- 3) Press the SCROLL button to begin modifying the timer options.



## 6.2 Light Effect Mode

In addition to being able to change the light colour, the SP1200 also has the ability to produce various lighting effects while cycling through each of the available colours. The Light Effect Mode, UP and DOWN buttons are used to select the lighting effect or colour of choice.

Seven pushes of the Light Effect Mode button cycle the light mode setting as follows:

Push 1  
(Light On)



LCD Displays "FIXED WHITE", Light is pure white, no light effect. Pressing either the UP or DOWN button selects the Preset Colour mode (see below)

Push 2  
(Change Colour)

LCD Displays "PRESET COLOUR", Light colour depends on previous selection (default white). The UP and DOWN buttons can be used to select a different colour of choice. Your chosen colour is saved and will be automatically restored next time you select Preset Colour mode.

Push 3  
(Change Effects)

LCD Displays "SMOOTH CHANGE", Light cycles through all of the available colours continuously without any delay for each colour. The UP and DOWN buttons may be used to change the speed of the light effect (see section 6.2.1 below).

Push 4  
(Change Effects)

LCD Displays "FADE UP/DOWN", Light cycles through all of the available colours one at a time. Each colour is faded in from zero intensity (light off) and then faded out to zero intensity. The UP and DOWN buttons may be used to change the speed of the light effect (see section 6.2.1 below).

Push 5  
(Change Effects)

LCD Displays "BURST UP/DOWN", Light cycles through all of the available colours one at a time. Very similar to FADE UP/DOWN, except that the colour fades in very fast and fades out slowly. The UP and DOWN buttons may be used to change the speed of the light effect (see section 6.2.1 below).

Push 6  
(Change Effects)

LCD Displays "DELAYED CHANGE", Light cycles through all of the available colours one at a time. Each colour is shown for a short period then the light will quickly fade to the next colour. The UP and DOWN buttons may be used to change the speed of the light effect (see section 6.2.1 below).

Push 7  
(Change Effects)

LCD Displays "STEP CHANGE", Light cycles through all of the available colours one at a time without any smooth fading between different colours. The UP and DOWN buttons may be used to change the speed of the light effect (see section 6.2.1 below).

This setting is saved and will be automatically restored next time you turn on the light.

### 6.2.1 Adjusting The Light Effect Mode Speed

When a light effect mode has been selected ("SMOOTH CHANGE" to "STEP CHANGE" see above) the speed at which the light cycles through the available colours may be manually adjusted. On the first press of UP/DOWN the LCD will display "EFFECT SPEED" along with a bar graph showing the current setting. While viewing this display you may press the UP and DOWN buttons to adjust the cycle speed as required. Hold down either button for automatic key press repeat. At the maximum setting of 100% the speed is approximately 40 times faster than the minimum setting of 2% and approximately 6 times faster than the default setting of 50%. The setting for each light effect is saved individually and will be restored next time you select the given light effect mode.

Down



Up



Notes:

- 1) The UP and DOWN buttons are shared with Light Level, Light Mode, SPVSB speed and the menu system. When not within the menu system the actual use of the UP and DOWN buttons depends on which of the three function buttons was pressed last - Light Level, Light Mode or Air.
- 2) Pressing either Light Level or Light Mode buttons while the light is on will only cycle through the available options when the LCD is displaying the current selection. This allows you to set the function of the UP and DOWN buttons and to view the current Light Level or Light Mode setting without changing them.
- 3) Pressing Light Mode button when light is off will turn on the light using Light Level High.
- 4) By default the touch pad panel backlight will mirror the pool setting, but this feature may be disabled. See section 7.8.7 on page 26

## 7 Menu Structure

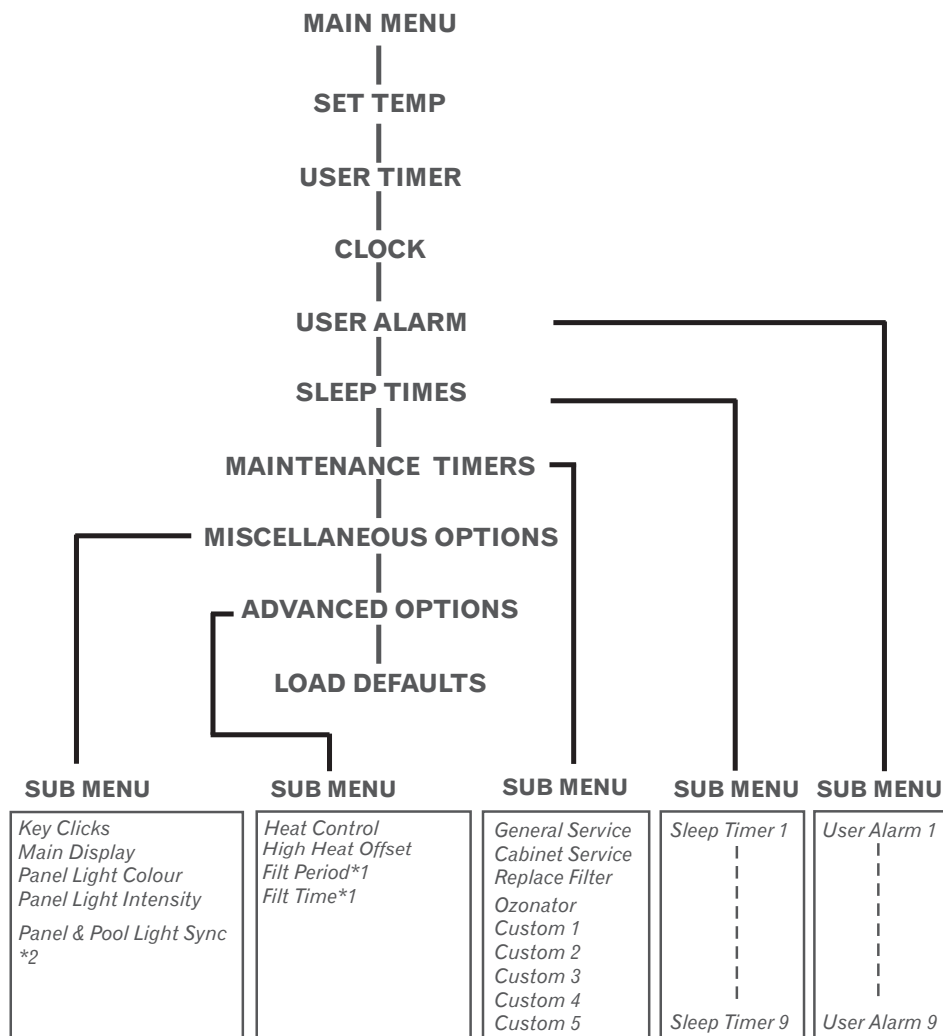

\*1 N/A for 24Hr circulation pump installations  
\*2 N/A if SPVCL not fitted

### 7.6.2 Disabling a sleep time period

If you want to disable a sleep period follow the procedure outlined in Configuring a sleep time until you reach step 4. At this point use the UP and DOWN buttons to adjust the weekday setting until no days are selected (see pic below). Press the SCROLL button to save the new setting and return to the sleep time submenu. This will completely disable the sleep period.

When the sleep period is disabled the start time is shown as below and the stop time cannot be selected within the sleep submenu.

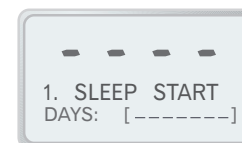

When you disable a sleep period in this manner the start and stop times are still retained and will be restored when you enable the sleep period by re-selecting one or more weekdays.

### 7.6.3 Plumbing purge

After the system resumes from a sleep period it will automatically run each of the accessory pumps one-by-one and then the blower for 10 seconds to purge the plumbing. This prevents any stagnant water from collecting in the pipes if the pool is not used for an extended period of time. While a plumbing purge is in progress "PURGING PUMPS, PLEASE WAIT" will be shown on the LCD display.

#### Notes

- For correct sleep operation ensure the clock is set correctly. You will need to set it the first time the controller is powered up or if the controller has been turned off for a long period.
- The maximum possible sleep time for one period is 23 hours, 59 minutes. This is achieved when the stop time is one minute before the start time. If the two times are equal the sleep period will have no effect.
- It is normal for the spa to run for a long period after sleep to recover temperature lost over night. Because of this it is advisable to configure the spa to wake up at least one hour before use of the spa is desired.

## 7.7 Maintenance timers

The SP1200 controller has nine programmable maintenance timers that will remind you when regular scheduled maintenance is due. Each timer can be configured to expire after 1 to 255 weeks or may be disabled altogether. All nine timers are disabled by default unless your spa builder/installer has set them.

The first four timers have specific names for specific tasks, but the remaining five are generic. Your spa installer may have chosen to use one or more of the custom programs for maintenance items not covered by the generic timers.

Once a timer period has expired the touch pad will inform you that maintenance is due in two ways:

- When the spa has not been used for over an hour the first key press will result in a long beep and text being displayed indicating which timer has expired. You will need to press the SCROLL button one or more times to clear this message.
- When not within the menu system and after approximately 10 seconds of inactivity, the touch pad LCD will periodically display text indicating which timer has expired. This text is displayed in place of the default main display text and does not interfere with the normal touch pad interface.

In both cases, the text displayed will be "MAINT REQD:" along with the name of the maintenance timer.

- 4) Use the UP and DOWN buttons to select the desired weekdays that the sleep period will operate. There are 15 possible weekday settings to choose from - Monday to Sunday and various combinations of each.
- 5) Press the SCROLL button to confirm the current setting and move to the next field.

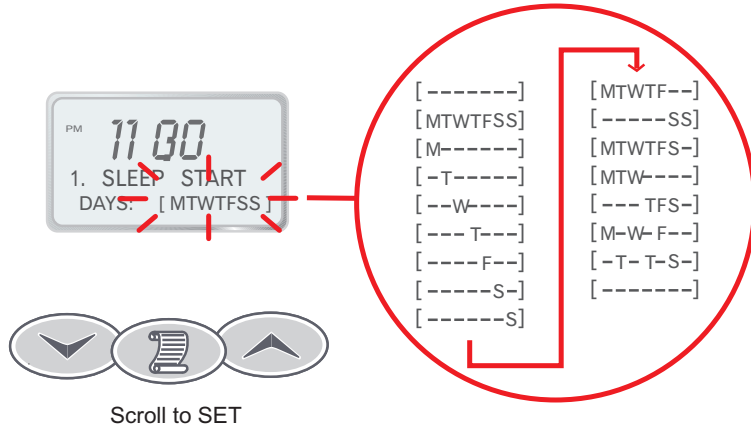

- 6) Repeat step four and five to carry on adjusting sleep start hours & minutes then sleep stop hours & minutes.  
Tip: As you modify the stop time the hours asleep field will change accordingly, use it to verify your new settings are correct.

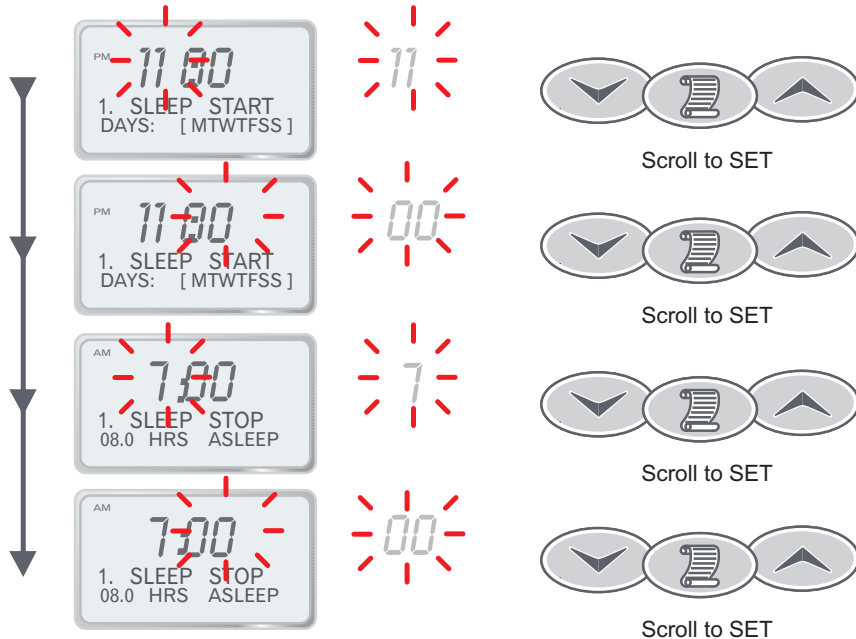

When the SCROLL button is pressed to set the sleep stop minutes the minutes will stop flashing and if desired more sleep periods can be set by repeating steps 6.

## Navigating The Menu System

The SP1200 menu system provides a simple interface that allows you to view and modify most user options. These options include set temperature, sleep times, filtration time and filtration period to name a few. Throughout the entire menu system only three touch pad buttons are used - DOWN, SCROLL and UP. Generally, while you are within the menu system the lower line of text on the LCD Display will show the function of each of these buttons.

To access the main menu from the default display, press the SCROLL button. The LCD display will change to show the Main Menu title. Each menu consists of a menu title and several menu items - menu items are numbered whereas the menu title is not. Use the UP and DOWN buttons to browse through the main menu.

If you do not press any touch pad buttons for over one minute while inside the menu system the display will automatically return back to the default view, however you do not need to wait for this timeout period. To quickly exit from the menu system, use the UP and DOWN buttons to select the current menu title and press the SCROLL button.

Note that while viewing the menu title the LCD Display text above the SCROLL button shows "(ESC)" to indicate that the function of the SCROLL button is to escape from the menu. The action taken by the SCROLL button is dependent on which menu item is selected and this is reflected by the LCD Display text above the SCROLL button.

The menu system contains five sub menus - User Alarms Menu, Sleep Times Menu, Maintenance Timers Menu, Miscellaneous Options Menu and Advanced Options Menu. These sub menus are accessed via main menu items 4 to 8 respectively. Simply select one of these items in the main menu and press the SCROLL button. You will now be in the given sub menu. Browse sub menus just as you would the main menu - the interface functions exactly the same.

To select any other item either within the main menu or any of the sub menus simply select the desired menu item using the UP and DOWN buttons then press the SCROLL button.

### 7.1 Main Menu

The main menu is the top level of the menu system. It provides quick access to the set temperature setting, user timer and clock. The five sub menus are also accessed via main menu items 4 to 8.

To access the main menu from the default view, simply press the SCROLL button. Please read "Navigating the menu system" section above if you have not already done so.

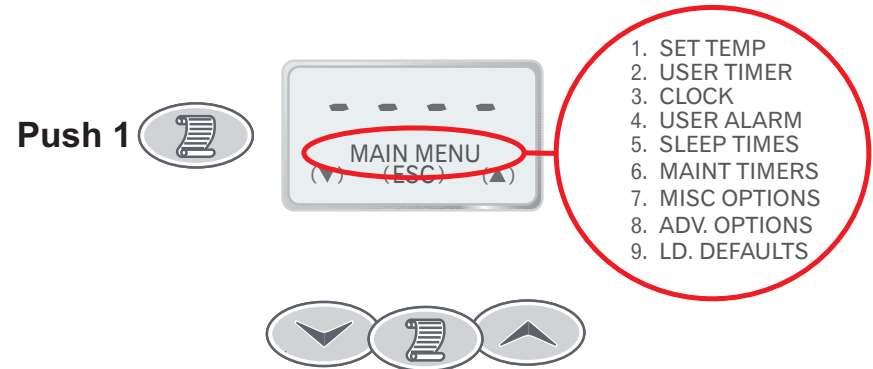

## 7.2 Set Temp (Temperature Control)

Select MAIN menu then push UP button once



1. SET TEMP
2. USER TIMER
3. CLOCK
4. USER ALARM
5. SLEEP TIMES
6. MAINT TIMERS
7. MISC OPTIONS
8. ADV. OPTIONS
9. LD. DEFAULTS



Scroll to SET

The SP1200 automatically controls the main pump and heater to filter the water and maintain it at the desired temperature set by the user. The user can leave the system to look after the spa and know it will be at the correct temperature whenever he or she wants to use it.

While viewing the set temp menu item, the current set temperature is displayed on the four numerical digits in degrees Celsius (default 37.00). The range of adjustment is 10.00 to 41.50 in steps of 0.25 degrees Celsius.

To change the setting press SCROLL while viewing the set temp menu item. The current setting will flash indicating that the value may now be changed. Use the UP and DOWN buttons to adjust the set temp as required. Hold down either button for automatic key press repeat. Press the SCROLL button once the desired value is reached. The final press of the SCROLL button will return you back to the default view (out of the menu system) and the new setting will take effect immediately.

Note: The pool temperature will be maintained close to the set temperature, but how close depends upon the "Heat Control" setting (see section 7.9.1).

## 7.6 Sleep Timer

Sleep is a very handy feature that is used to silence the spa pool during your hours of sleep. While the SP1200 is asleep no automatic heating or filtration maintenance will occur, however the spa can still be used in manual mode without having to change any settings.

There are a total of nine individual sleep times that can be programmed, each of which can operate on one or more specified weekdays. You may use as few or many of the sleep periods as you wish.

By default the spa will sleep between 11pm & 7am, Monday to Sunday. This is achieved using only sleep period one, the remaining eight sleep periods are disabled.

To review the current sleep settings simply select the sleep time submenu from the main menu. Within the submenu use the UP and DOWN buttons to browse through each of the nine sleep periods.

Each of the nine sleep periods consists of a weekday setting, start time and stop time. These three settings are displayed using two sleep time submenu items: "#. SLEEP START" and "#. SLEEP STOP" (where # is the sleep period number 1 to 9).

### 7.6.1 Configuring A Sleep Time

Follow these steps to set an unused sleep period, or to modify an enabled sleep period:

Select MAIN menu then push UP button five times

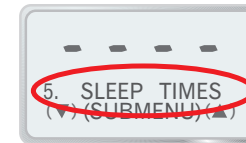

1. SET TEMP
2. USER TIMER
3. CLOCK
4. USER ALARM
5. SLEEP TIMES
6. MAINT TIMERS
7. MISC OPTIONS
8. ADV. OPTIONS
9. LD. DEFAULTS

1) Select the SLEEP TIMES submenu by pressing the SCROLL button.



2) Use the UP and DOWN buttons to select the desired sleep period.

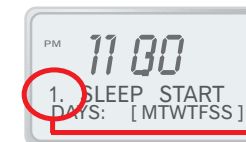

Sleep period (1-9)

3) Press SCROLL to start modifying the sleep start day.





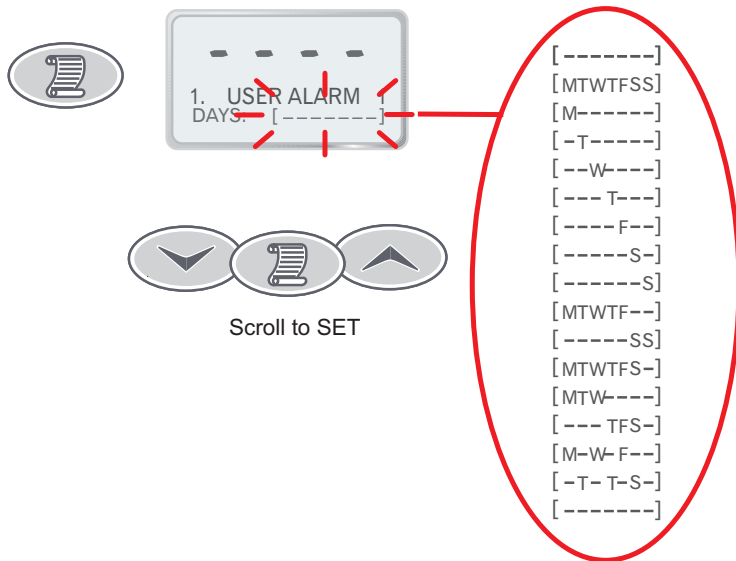

- 3) Press the SCROLL button to confirm the current setting and move to the next field.
- 4) Repeat steps 2 & 3 to set the alarm time hours and minutes.
- 5) Press the SCROLL button to save the new settings and return to the user alarms submenu.

### 7.5.2 Disabling A User Alarm

If you want to disable a user alarm follow the procedure outlined above until you reach step 4. At this point use the UP and DOWN buttons to adjust the weekday setting until no days are selected (see display below).

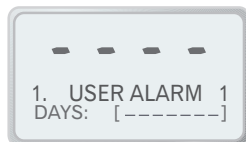

Press the SCROLL button to save the new setting and return to the user alarms submenu. This will completely disable the user alarm.

When you disable a user alarm in this manner the alarm time (hour and minute) is still retained and will be restored when you enable the user alarm by re-selecting one or more weekdays.

### 7.3 User Timer

The user timer is a general-purpose count down minute timer that can be preset to start at anywhere between 1 and 99 minutes. You can set it when you get into the spa to have it remind you when its time to get out.

The timer will count down the specified period and show minutes and seconds remaining on the LCD Display as it does. A double beep is produced for each of the last 10 seconds, finishing with one long beep and the message "USER TIMER FINISHED" when the timer is done.

To use the user timer, first select it from the main menu. The total time will flash on the LCD (default 30 minutes). Use the UP and DOWN buttons to adjust the time as required. Hold down either button for automatic key press repeat. Press the SCROLL button once the desired time is reached. This will set the timer running and the message "TIMER STARTED (STOP)" will be displayed. While this message is being displayed you may immediately stop the timer by pressing SCROLL again. Otherwise wait approximately five seconds for the message to disappear and you will be returned back to the default view with the timer running in the background.

Select MAIN menu then push UP button twice



1. SET TEMP
2. USER TIMER
3. CLOCK
4. USER ALARM
5. SLEEP TIMES
6. MAINT TIMERS
7. MISC OPTIONS
8. ADV. OPTIONS
9. LD. DEFAULTS

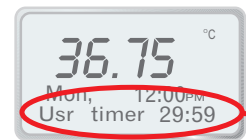

USER TIMER counting down

### 7.4 Clock

The SP1200 contains a real time clock that will retain the correct time even during short power cuts. The clock provides the user with a convenient way to tell the time in the pool and is also used to time sleep periods, filtration timing and the user timers.

The clock can be configured to operate in either 12 or 24 hour mode. This setting will also determine the way user alarms, sleep start and sleep stop times are displayed.



1. SET TEMP
2. USER TIMER
3. CLOCK
4. USER ALARM
5. SLEEP TIMES
6. MAINT TIMERS
7. MISC OPTIONS
8. ADV. OPTIONS
9. LD. DEFAULTS

## 7.4.1 Setting The Clock

- 1) Select the clock menu item from within the main menu.



- 2) Press the SCROLL button to begin setting the clock.



- 3) Use the UP and DOWN buttons to select the desired clock mode (24hr or 12hr).
- 4) Press the SCROLL button to confirm the current setting and move to the next field.
- 5) Use the UP and DOWN buttons to adjust the selected field as required. Hold down either button for automatic key press repeat.
- 6) Repeat until Mode, Hours, Minutes and Week Day have been set.

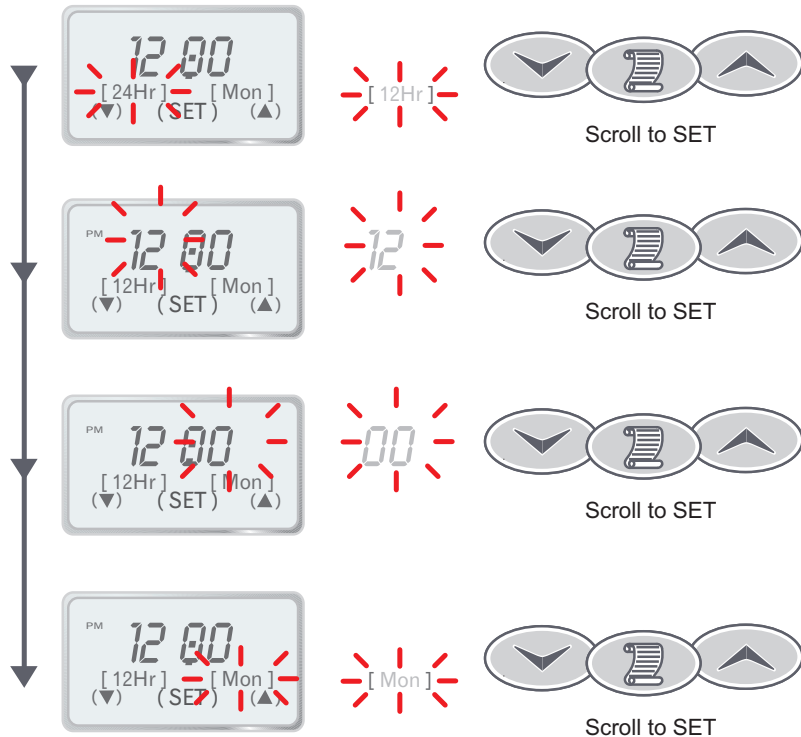

When SCROLL is pressed to set the day of the week the display reverts back to the default display.

## 7.5 User Alarms

The SP1200 controller has nine user programmable alarms that you can configure to go off at a preset time while you are using the spa. These alarms function similarly to a regular clock alarm but with the additional benefit that you can also specify which days the alarm should operate.

When an alarm goes off the touch pad will beep and display the current time and text indicating which alarm number is active. Beeping will continue for one minute or until you press a button on the touch pad. There is no effect on any other spa functions such as pumps, blower, light etc.

Select MAIN menu then push UP button four times

Push 4 

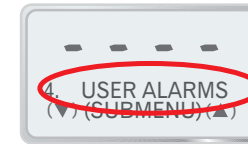

1. SET TEMP
2. USER TIMER
3. CLOCK
4. USER ALARM
5. SLEEP TIMES
6. MAINT TIMERS
7. MISC OPTIONS
8. ADV. OPTIONS
9. LD. DEFAULTS

### 7.5.1 Configuring a user alarm

- 1) Select the USER ALARMS submenu by pressing the SCROLL button.



- 2) Use the UP and DOWN buttons to select the desired weekdays that the user alarm will operate. There are 15 possible weekday settings to choose from - Monday to Sunday and various combinations of each.

